

COMMODORE C4800c

TECHNICAL DATA

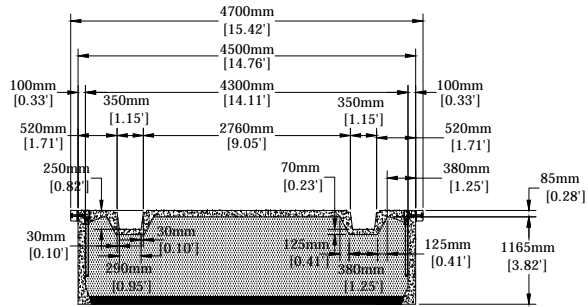

COMMODORE C4800c
SECTION A-A

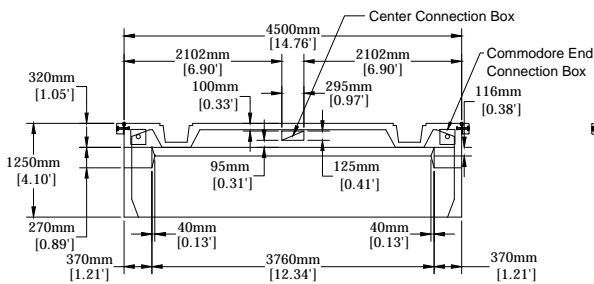

END ELEVATION VIEW

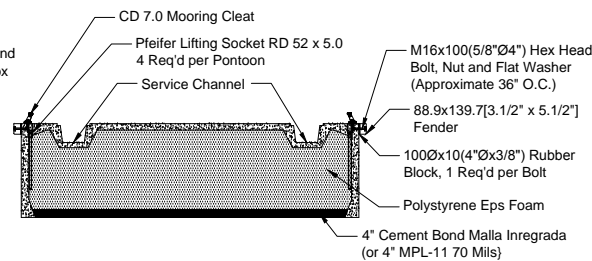

SECTION A-A
SCALE 3/8" = 1'

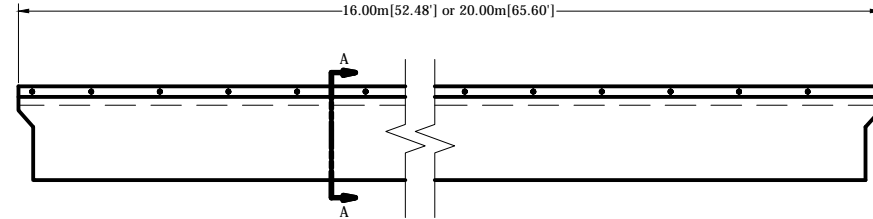

SIDE ELEVATION VIEW

COMMODORE C4800c [15' width] with Two Service Channels Technical Data

Model	Total Width (meter/feet)	Concrete Width (meter/feet)	Height (meter/feet)	Length (meter/feet)	Freeboard (mm/inch)	Area (square meter/squarefeet)	Volume (cubic meter/cubic yard)	Weight (kg/lbs)	Type
C4816c[15'x52.48']	4.70/15.42	4.50/14.76	1.25/4.10	16.00/52.48	650-700/25.58-27.55	72/775.01	88.62/115.91	38200-40090/84216-88382	Concrete
C4820c[15'x65.60']	4.70/15.42	4.50/14.76	1.25/4.10	20.00/65.60	650-700/25.58-27.55	90/968.76	110.28/144.24	46500-49920/102514-110054	Concrete